

Model No.DDF482 CORDLESS DRIVER DRILL

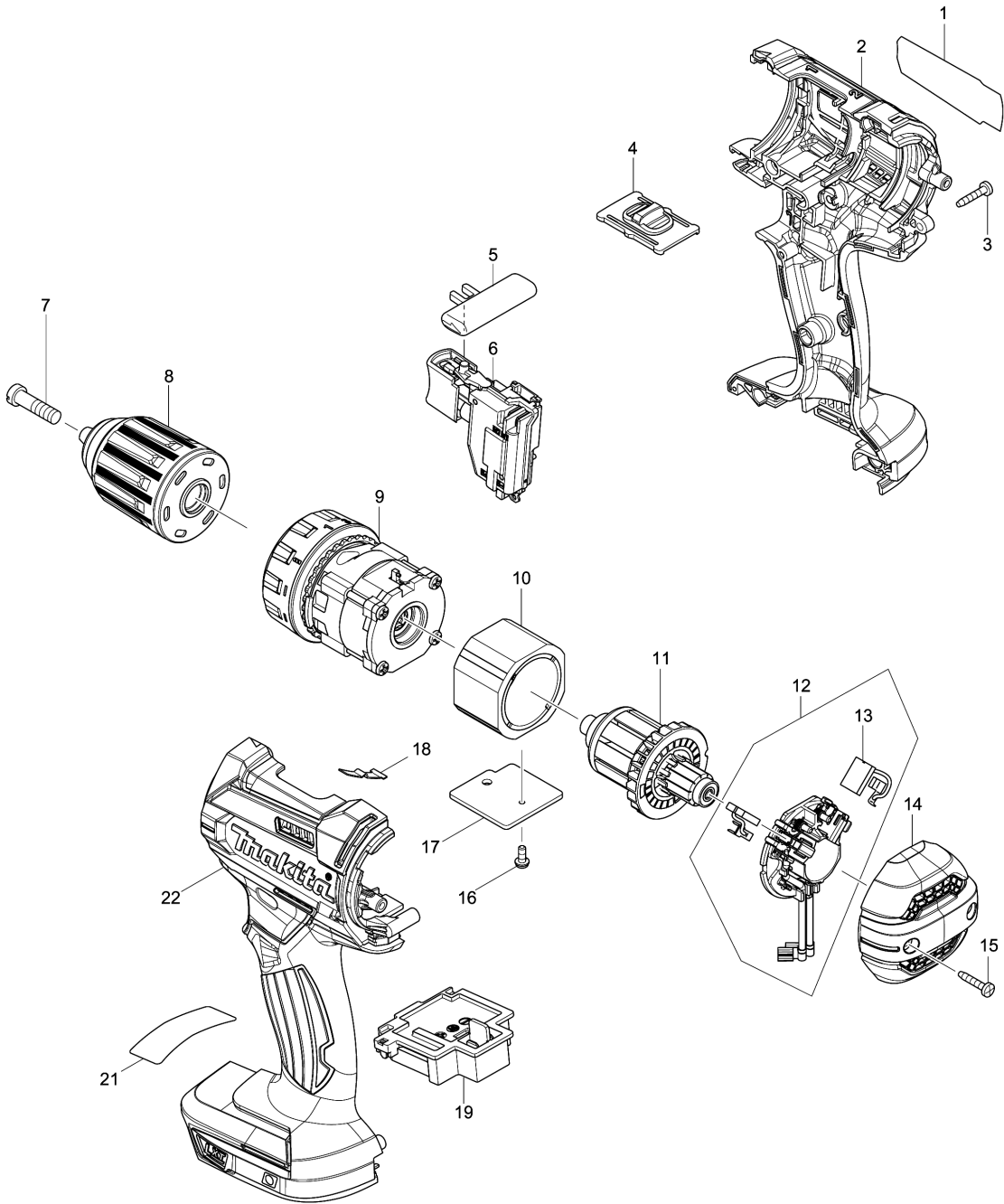

Model No.DDF482 CORDLESS DRIVER DRILL

Položaj	Številka dela	Opis	Sprememba	Količina	New/Old	Opcijsko 1	Opcijsko 2	Opomba
001	851E35-2	DDF482 NAME PLATE		1				
002	183B65-0	HOUSING SET		1				
C10	263005-3	Gumi zatič 6		2				
D10		INC. 22						
003	266429-2	Samovrezni vijak 3x16		9				
004	123442-2	SPEED CHANGE LEVER ASSEMBLY		1				
C10	233438-6	Tlačna spiralna vzmet 4		2				
005	419041-9	Gumb L/D		1				
006	632F27-4	SWITCH UNIT		1				
C10	620444-4	LED CIRCUIT		1				
C20	688172-7	LINE FILTER		1				
007	251468-5	Vijak z ravno glavo levi navoj M6x22 MT064		1				
008	766027-7	KEYLESS DRILL CHUCK 13		1				
009	123444-8	GEAR ASSEMBLY		1	*			
009-1	127323-2	GEAR ASSEMBLY	<	1	*			
009-2	127511-1	GEAR ASSEMBLY	<	1				
010C	632F32-1	YOKE UNIT		1	*			
010D	632F32-1	YOKE UNIT		1	*			
010E	632F32-1	YOKE UNIT		1	*			
010-1C	632J70-7	YOKE UNIT	<	1				
010-1D	632J70-7	YOKE UNIT	<	1				
010-1E	632J70-7	YOKE UNIT	<	1				
010-1G	632J70-7	YOKE UNIT		1				
010-1H	632J70-7	YOKE UNIT		1				
010-1I	632J70-7	YOKE UNIT		1				
010-1J	632J70-7	YOKE UNIT		1				
010-1K	632J70-7	YOKE UNIT		1				
011	619380-9	ARMATURE		1				
012	632F21-6	BRUSH HOLDER COMPLETE		1				
C10	688172-7	LINE FILTER		1				
D10		INC. 13						
013	194427-5	Grafitne ščetke CB-440		1				
014	456099-7	REAR COVER		1				
015	266429-2	Samovrezni vijak 3x16		2				
016C	911006-2	Vijak z nizko cilindrično glavo M3x8		1	*			
016D	911006-2	Vijak z nizko cilindrično glavo M3x8		1	*			
016E	911006-2	Vijak z nizko cilindrično glavo M3x8		1	*			
016-1C	652066-2	+PAN HEAD SCREW M3X9 WITH W	<	1				
016-1D	652066-2	+PAN HEAD SCREW M3X9 WITH W	<	1				

Model No.DDF482 CORDLESS DRIVER DRILL

Položaj	Številka dela	Opis	Sprememba	Količina	New/Old	Opcijsko 1	Opcijsko 2	Opomba
016-1E	652066-2	+PAN HEAD SCREW M3X9 WITH W	<	1				
016-1G	652066-2	+PAN HEAD SCREW M3X9 WITH W		1				
016-1H	652066-2	+PAN HEAD SCREW M3X9 WITH W		1				
016-1I	652066-2	+PAN HEAD SCREW M3X9 WITH W		1				
016-1J	652066-2	+PAN HEAD SCREW M3X9 WITH W		1				
016-1K	652066-2	+PAN HEAD SCREW M3X9 WITH W		1				
017	689070-8	HEAT SINK		1				
018	232182-2	Listnata vzmet		1				
019	644808-8	TERMINAL BHR242, DHR242		1				
022	183B65-0	HOUSING SET		1				
C10	263005-3	Gumi zatič 6		2				
D10		INC. 2						
A01	251314-2	Vijak M4x12		1				
A02C	346317-0	Obešalni kavelj vijačnika		1				
A02D	346317-0	Obešalni kavelj vijačnika		1				
A02E	346449-3	HOOK BTD146,BTD134D		1				
A02G	346317-0	Obešalni kavelj vijačnika		1				
A02H	346317-0	Obešalni kavelj vijačnika		1				
A02I	346317-0	Obešalni kavelj vijačnika		1				
A02J	346317-0	Obešalni kavelj vijačnika		1				
A02K	346317-0	Obešalni kavelj vijačnika		1				
A03	784637-8	BIT 2-45		1				
A04D	821550-0	Makpac kovček za prenašanje 395 x 295 x 157mm		1				
C10	453974-8	Plastična zaponka za MAKPAC plastične kovček		4				
A04E	821550-0	Makpac kovček za prenašanje 395 x 295 x 157mm		1				
C10	453974-8	Plastična zaponka za MAKPAC plastične kovček		4				
A04G	141856-3	Plastični kovček kpl. DF456D		1				
C10	162302-3	Zapiralo za HR2610		2				
C20	324207-7	Pogonska gred		1				
C30	451749-9	Ročaj HR2610		1				
A04H	141856-3	Plastični kovček kpl. DF456D		1				
C10	162302-3	Zapiralo za HR2610		2				
C20	324207-7	Pogonska gred		1				
C30	451749-9	Ročaj HR2610		1				
A04I	141856-3	Plastični kovček kpl. DF456D		1				

Model No.DDF482 CORDLESS DRIVER DRILL

Položaj	Številka dela	Opis	Sprememba	Količina	New/Old	Opcijsko 1	Opcijsko 2	Opomba
C10	162302-3	Zapiralo za HR2610		2				
C20	324207-7	Pogonska gred		1				
C30	451749-9	Ročaj HR2610		1				
A04J	141856-3	Plastični kovček kpl. DF456D		1				
C10	162302-3	Zapiralo za HR2610		2				
C20	324207-7	Pogonska gred		1				
C30	451749-9	Ročaj HR2610		1				
A04K	821550-0	Makpac kovček za prenašanje 395 x 295 x 157mm		1				
C10	453974-8	Plastična zaponka za MAKPAC plastične kovček		4				
A05D	450128-8	Pokrov za baterijo		1				
A05E	450128-8	Pokrov za baterijo		1				
A05G	450128-8	Pokrov za baterijo		1				
A05H	450128-8	Pokrov za baterijo		2				
A05I	450128-8	Pokrov za baterijo		1				
A05K	450128-8	Pokrov za baterijo		2				
A06D	***DC18RC	DC18RC FAST CHARGER		1				
A06E	***DC18RC	DC18RC FAST CHARGER		1				
A06G	***DC18RC	DC18RC FAST CHARGER		1				
A06H	***DC18RC	DC18RC FAST CHARGER		1				
A06I	***DC18RC	DC18RC FAST CHARGER		1				
A06J	***DC18RC	DC18RC FAST CHARGER		1				
A06K	***DC18RC	DC18RC FAST CHARGER		1				
A07D	197265-4	BATTERY BL1840B SET		2	*			
A07E	197254-9	BATTERY BL1820B SET		2	*			
A07K	197280-8	BATTERY BL1850B SET		3	*			
A07-1D	197265-4	BATTERY BL1840B SET	O	2				
A07-1E	197254-9	BATTERY BL1820B SET	O	2				
A07-1G	197265-4	BATTERY BL1840B SET		2	*			
A07-1H	197600-6	BATTERY BL1830B SET		3	*			
A07-1I	197600-6	BATTERY BL1830B SET		2	*			
A07-1J	197600-6	BATTERY BL1830B SET		1	*			
A07-1K	197280-8	BATTERY BL1850B SET	O	3				
A07-2G	197265-4	BATTERY BL1840B SET	O	2				
A07-2H	197600-6	BATTERY BL1830B SET	O	3				
A07-2I	197600-6	BATTERY BL1830B SET	O	2				
A07-2J	197600-6	BATTERY BL1830B SET	O	1				
A08D	837916-4	Makpac type 1 inner layout - BDF343		1				
A08E	837863-9	INNER TRAY		1				
A08G	807S08-7	DDF482RME PLASTIC CASE LABEL		2	*			

Model No.DDF482 CORDLESS DRIVER DRILL

Položaj	Številka dela	Opis	Sprememba	Količina	New/Old	Opcijsko 1	Opcijsko 2	Opomba
A08H	808Y46-8	DDF482RFE3 PLASTIC CASE LABEL		2	*			
A08I	816F03-8	DDF482RFE PLASTIC CASE LABEL		2				
A08K	837916-4	Makpac type 1 inner layout - BDF343		1				
A08-1G	816E97-7	DDF482RME PLASTIC CASE LABEL	X	2	*			
A08-1H	816F05-4	DDF482RFE3 PLASTIC CASE LABEL	X	2				
A08-1J	817V67-1	DDF482RF PLASTIC CASE LABEL		2				
A08-2G	816E98-5	DDF482RME PLASTIC CASE LABEL	O	2				
A09D	808J25-6	DDF482RMJ INDICATION LABEL		1	*			
A09E	808J27-2	DDF482RAJ INDICATION LABEL		1	*			
A09-1D	816F10-1	DDF482RMJ INDICATION LABEL	O	1				
A09-1E	816F12-7	DDF482RAJ INDICATION LABEL	O	1				
A09-1K	816F27-4	DDF482RT3J INDICATION LABEL		1				
A10D	808J26-4	DDF482RMJ PLASTIC CASE LABEL		2	*			
A10E	808J28-0	DDF482RAJ PLASTIC CASE LABEL		2	*			
A10-1D	816F11-9	DDF482RMJ PLASTIC CASE LABEL	X	2				
A10-1E	816F13-5	DDF482RAJ PLASTIC CASE LABEL	X	2	*			
A10-1K	816F28-2	DDF482RT3J PLASTIC CASE LABEL		2				
A10-2E	816F14-3	DDF482RAJ PLASTIC CASE LABEL	O	2				

Please order the parts with part number.

Print Date 20/1/2021